

ROC documentation

Version zeus-1

Table of Contents

User manual for the ROC web application	6
• Introduction	7
• Home page	8
• On a ROC-E robot	8
• Multi destinations	8
• Ordered multi destinations	9
• Predefined messages	9
• On a manager	11
• Configuration	12
• ROC	12
• General	13
• Manager	13
• Vehicle	14
• Vehicle - Size	15
• Vehicle - Delays	16
• Buttons	17
• Add a button	17
• Vehicles	19
• Waiting points	19
• Custom commands	20
• LoRa controllers	20
• Predefined messages	21
• Noeme application	21
• Map	21
• Add a location	21
• Modify a position	22
• Groups	24
• Lift	24
• Security	25
• Connectivity	25
• Port redirections	26
• Select map	26
• Import / Export	27
• Languages	27

• User accounts	27
• Sound volumes	28
• Maintenance mode	28
• Refresh	28
• Restart	29
• Statistics	30
• Home	30
• Calls	30
• Calls by button	30
• Destinations	30
• Delays	30
• Movement error	31
• HIR	31
• Missions	32
• Creating a new mission	32
• Create new mission	32
• Start button mission	33
• Mission lists	33
• Mission	33
• Mission details	34
• Release a robot	34
• Extend a mission	35
Call buttons user manual	36
• How it works	37
• Start a call	37
• Cancel a call	38
• Recharge the button battery	38
• Configuration	12
• Menu	39
• LoRa SP	39
• Button	39
• Secure LoRa	40
LoRa controllers user manual	41
• Principle	42
• Views	43

• Configuration	12
• Menu	39
• LoRa	44
• Controller	44
• Relays	45
• Relay	45
• Relay - Set pulse time	45
• Relay - Test	45
• Contacts	46
• Contact	46
• Contact <i>Call / Priority call</i>	46
• Contact <i>Availability</i>	47
• Contact <i>Release robot</i>	47
• Secure LoRa	40
Case studies	48
• Set up a shelf	49
• Description	49
• Configuration	12
• Position for shelf mounting	49
• Position for shelf unload	50
• Set up a picking station	51
• Description	21
• Configuration	8
• Configure door opening	52
• Description	9
• Installing the LoRa controller	52
• Connection	52
• Configuration	9
• Test	53
• Preparation of areas	53
• Configuration	9
• Add the LoRa controller	54
• Configuring custom commands	54
• Set up a waiting point	55
• Description	10

• Preparation of areas	12
• Area to be cleared	55
• Waiting position	56
• Configuration	13
• Set up predefined messages	57
• Description	13
• Configuration	14
• Usage	57
• Synchronize robots and manager	59
• Description	15
• Export	59
• Import	60
• Add constraints on button missions	61
• Description	16
• Prerequisites	61
• Configuration	17
• My robot isn't moving anymore. Why?	62
• My robot is jerking in some places, what should I do?	63
• Description	18
• Configuration	18
• My robot is lost, what should I do?	64
• Description	19
• Relocate	64
• Configuration	19
• My robot is having trouble entering an area. What should I do?	66
• Description	19
• Configuration	20
• Turns	66
• Doors	67
• One-way routes	68
• Description	20
• Configuration	21
• Add an item with an identical marker already present on the map	69
• Description	22
• Tip	69

User manual for the ROC web application

Introduction

This ROC-E / ROC-M application manual describes all functions and how they work.

It covers use of the application on a ROC-E robot and on a ROC-M manager.

Home page

On a ROC-E robot

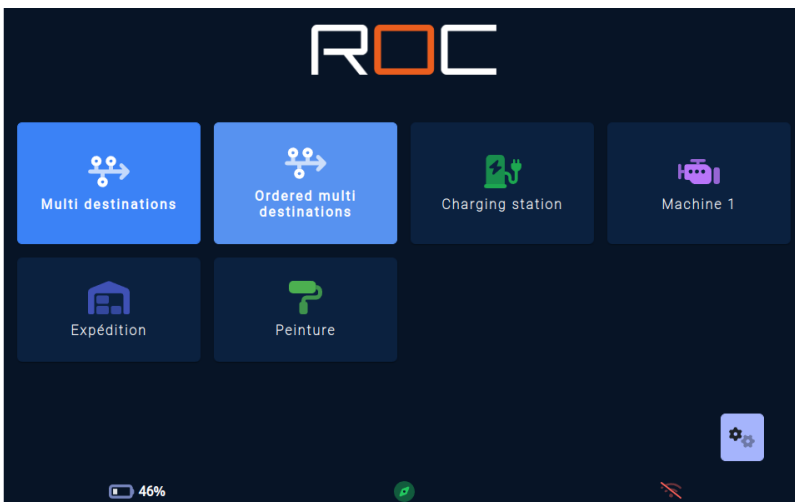

The home page displays the list of destinations stored in the robot's map in the form of a large button.

Pressing one of these buttons sends a command to the robot to move to the associated destination.

The button at bottom right gives access to the application configuration.

Multi destinations

By clicking on the **Multi destinations** button, you can ask the robot to move to several positions in the same mission by selecting the desired destinations. The robot will move from destination to destination, from closest to closest.

Once the robot has reached a destination, the operator can only release the robot to move on to its next destination (he cannot ask the robot to go to another destination).

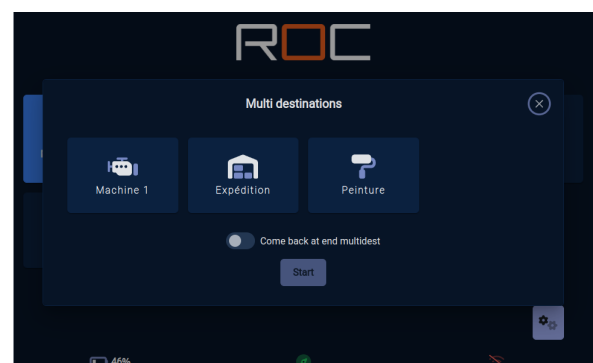

Ordered multi destinations

By clicking on the **Ordered multi destinations** button, you can instruct the robot to move to several positions in the same mission in a fixed order by selecting the desired destinations. The robot will move from destination to destination in the desired order.

Once the robot has reached a destination, the operator can only release the robot to move on to its next destination (he cannot ask the robot to go to another destination).

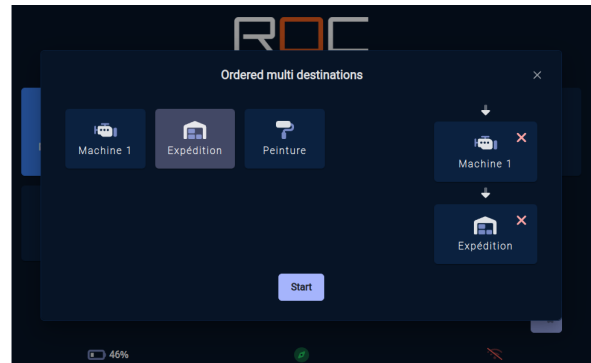

Predefined messages

If predefined messages have been configured, a button with 2 bubbles appears at the top right.

This button is used to select a predefined message to be displayed once the robot has reached its destination for the current mission.

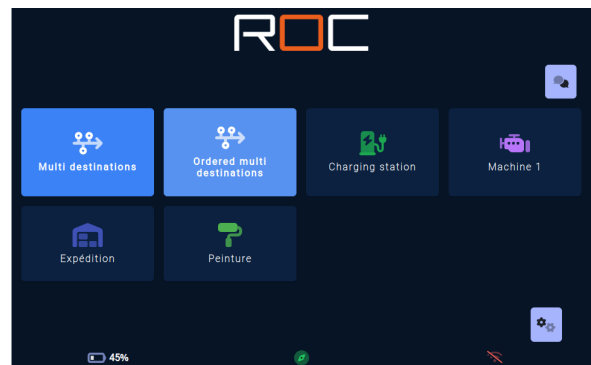

In the case of multi destinations, the message can be customised for each destination by clicking on the button associated with the destination.

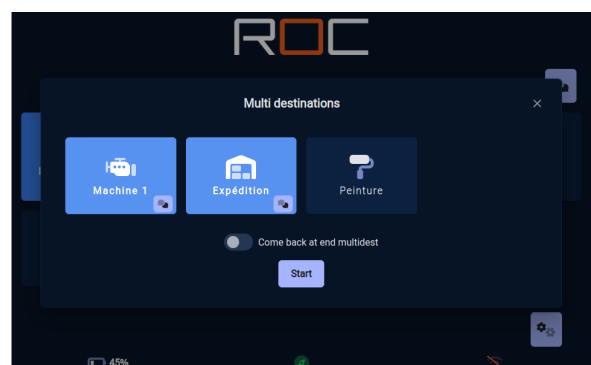

In the case of ordered multi destinations, the message can be customised for each destination by clicking on the button associated with the destination.

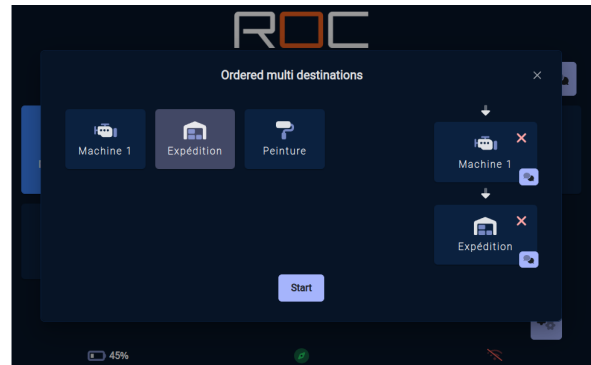

On a manager



3 buttons at the bottom of the screen give access to different sections:

- The button on the left gives access to the list of current missions.
- The button on the right gives access to the application configuration.
- The central button gives access to usage statistics.

Configuration

The configuration page allows you to configure the tool.

Depending on your configuration (e.g. manager or not), some options may not be available.

This page takes you to the following sections:

- **ROC** : for general module configuration.
- **Buttons** : add / modify / delete call buttons.
- **Vehicles** : manage the list of fleet vehicles.
- **Waiting poses** : add / modify / delete waiting points.
- **Custom commands** : add / modify / delete custom commands.
- **LoRa Controllers** : add / modify / delete LoRa controllers.
- **Predefined messages** : add / modify / delete predefined messages.
- **Noeme application** : access the Noeme application.
- **Map** : manage destinations.
- **Lift** : to interact with the ROC-P module lift (visible only if the module is configured, see *Vehicle - Size*).
- **Security** : to enable/disable features.
- **Connectivity** : manage the different WiFi connections of ROC and Noeme.
- **Select map** : manage the active map.
- **Import / Export** : export / import configurations.
- **Languages** : select the interface language.
- **Accounts** : add / modify / delete a user account.
- **Sounds volumes** : configure different sound volumes.
- **Maintenance mode** : activate or deactivate maintenance mode (manager only).
- **Refresh** : update the page (perhaps useful when updating the application).
- **Reboot** : restart the ROC application.

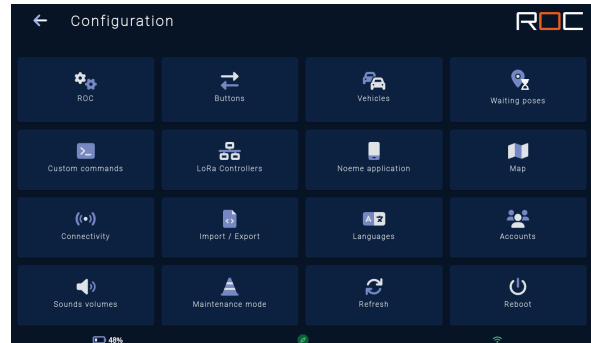

ROC

This configuration page lets you access certain information (application version, ROC Id...) and configure various application parameters.

General

This page allows you to view/modify the following parameters:

- **App version** : installed application version.
- **ROC Id** : unique module identifier.
- **LoRa SP** : configuration of LoRa communication spread factor; must be the same as call buttons, manager and other robots. Possible values from 7 to 12.
The higher the value, the slower the communication but the longer the range.
- **Password** : password to access the **Configuration** section.
- **Is manager** : indicate whether the active equipment is the manager or not.
- **Is vehicle** : indicate whether the active equipment is connected to a Noeme vehicle.
- **Virtual keyboard** : Whether or not to use the virtual keyboard.

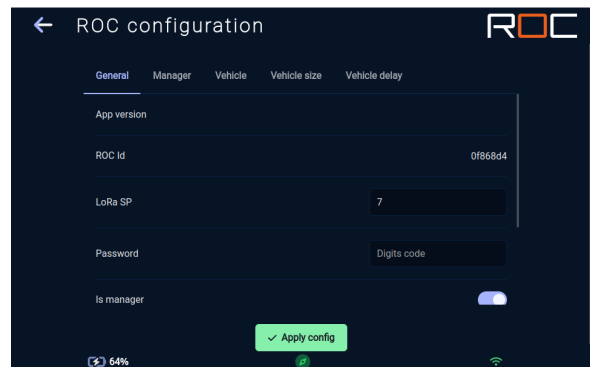

Manager

This page allows you to view/modify the following parameters:

If the manager is also a vehicle:

- **Response deadline** : waiting times for call equipments responses.

If the manager is not also a vehicle :

- **Default response deadline** : default waiting times for call button and LoRa controller responses.
- **Vehicle response deadline** : waiting times for vehicle responses.
- **Allow multiple mission for the same button** : allow to create multiple mission for the same button from API or Modbus.

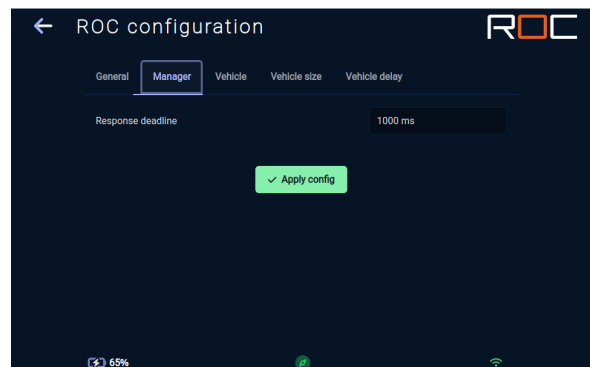

Vehicle

This page allows you to view/modify the following parameters:

- **Allow move from dock** : allow a user to start a new mission when the robot is waiting at its charging station.
- **Vehicle Id** : unique vehicle identifier.
- **Mast position** : to indicate the position of the mast on the robot; indicate **Front** if the mast is on the side of the vehicle's white lights, **Back** otherwise..
- **Direction to the charging station** : to indicate which way the vehicle should connect to the charging station; indicate **Front** for the vehicle to connect on the side of the vehicle's white lights, **Back** otherwise.
- **LoRa module ID** : LoRa module identifier for communication. Must be unique and reported on the manager.
- **Put the screen to sleep** : Put the screen to sleep when robot enter in sleep mode.
- **Allow follow me** : Allow follow me when the robot is stopped.
- **Default wait release sound** : Select the default wait release sound when the robot is in wating release on a saved pose.
- **Nb retry on move failed on first step** : number of move attempts if move fails at first stage.
- **Nb retry on move failed on other step** : number of move attempts if move fails at other stages.
- **Nb retry on move failed on multidest** : number of retry attempts in the event of a failed multidestination trip.
- **Veh to destination, distance goal tolerance** : distance in cm around the destination where the robot is considered to have arrived.
- **Veh to destination, yaw goal tolerance** : angle in degrees with respect to the destination where the robot is considered to have arrived.

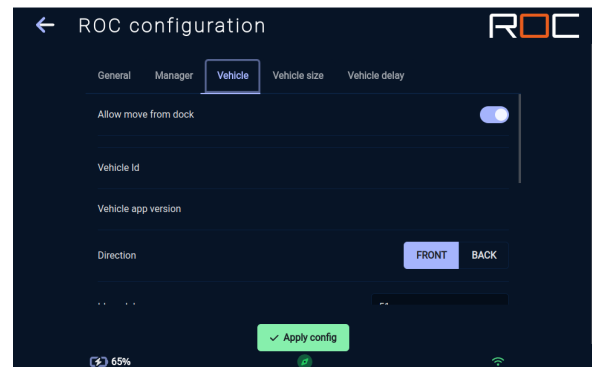

Vehicle - Size

This page allows you to view/modify the following parameters:

- **ROC Module** : type of active ROC module.
- **Max weight** : maximum weight of the robot with its load.
- **Height** : total height of the robot.

If the module is of type ROC-EP or ROC-P

- **Charge width** : width of the load being transported.
- **Charge depth** : depth of the load being transported.
- **Height with charge** : total height of the robot with its load.
- **Charge max speed** : maximum speed of the robot authorised when carrying the load.

If the module is of type **Other**

- **Max width** : maximum width of the robot.
- **Max depth** : maximum depth of the robot.

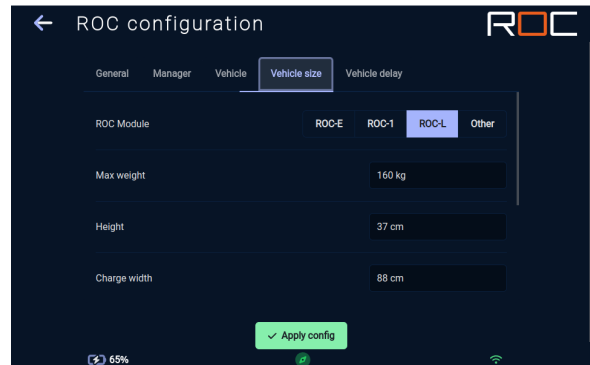

Vehicle - Delays

This page allows you to view/modify the following parameters:

- **Delay auto release** : automatic release delay on arrival at first stage (robot without load).
- **Delay auto release in multideestination** : automatic release delay on arrival at other stages (robot potentially loaded).
- **Delay between sound on wait release** : delay between 2 tones to indicate waiting for release.
- **Delay between retry on move failed** : waiting time between 2 attempts if the move fails.
- **Delay before retry on waiting pose** : waiting time before retry when the robot is in a waiting position.
- **Delay before standby** : waiting times once the robot is charging and before it goes into standby.
- **Delay between 2 attempts when paused** : waiting time before automatically resuming a paused move.
- **Lift - Delay in continuing to ascend after contact** : the elevator will continue to ascend after detecting contact for the defined delay. Used for attaching to shelves, this setting is only visible for ROC-P or ROC-EP type tops.

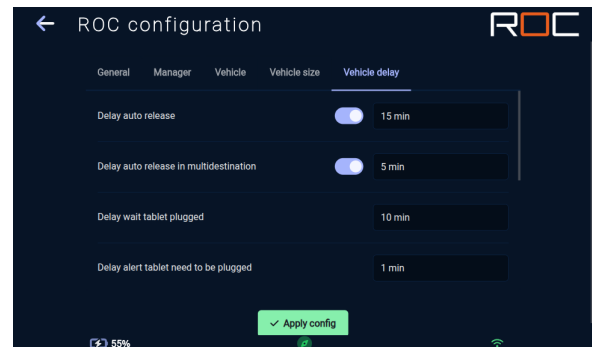

Some delays can be activated/deactivated with a switch. When the delay is disabled, the functionality is deactivated, for example: if the switch for **delay before standby** is disabled, the vehicle will never go to standby.

Buttons

This page lists the configured buttons.

To add a new button, click on the "Add button" button.

To modify a new button, click on the pencil associated with the button.

To delete a button, click on the red cross associated with it.

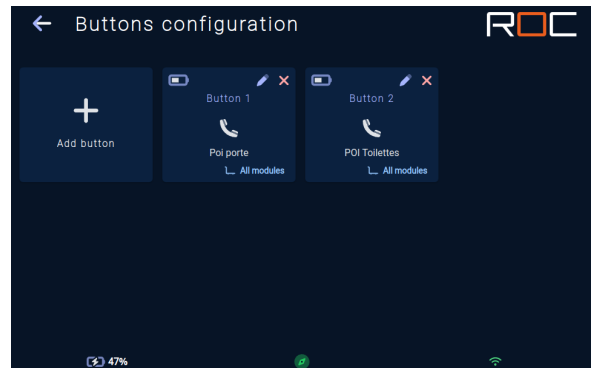

Add a button

To add a new button configuration, click on the "Add button" button.

If the application is configured as manager and vehicle, an automatic mode will be proposed; otherwise, the manual mode will be displayed.

Follow the steps to create a new button.

Button type

The application currently supports 5 button types:

- **Call button** : Once there, the user can choose the next step or release the robot..
- **Restocking button** : When the associated button is pressed, the robot will move to the first associated destination. Once there, the user can only release the robot, and it will move to the second associated destination. This type of configuration may be useful in the case of workstation replenishment, where the call is launched from the workstation, and the robot moves first to the warehouse where it will be loaded, and then to the user's workstation.
- **Multidestination button** : When the associated button is pressed, the robot will move to all associated destinations, from nearer to nearer.
- **Multidestination and back button** : When the associated button is pressed, the robot will move to all the associated destinations, from nearest to nearest, ending at a specific, configured last position.
- **Ordered multidestination** : When the associated button is pressed, the robot will move to all associated destinations in the defined order.



A button can be declared “virtual”; in this case, it will never be interrogated by the manager and can only be “called” via the modbus protocol or APIs.

Constraints

For each step, you can set constraints by clicking on the padlock associated with the step.

These constraints are linked to the LoRa controllers connected to the solution (see section on LoRa controllers);

To define a constraint, you must indicate:

- the LoRa controller where the sensor that will define the constraint is connected
- the LoRa controller contact
- the state of the contact expected to validate the step

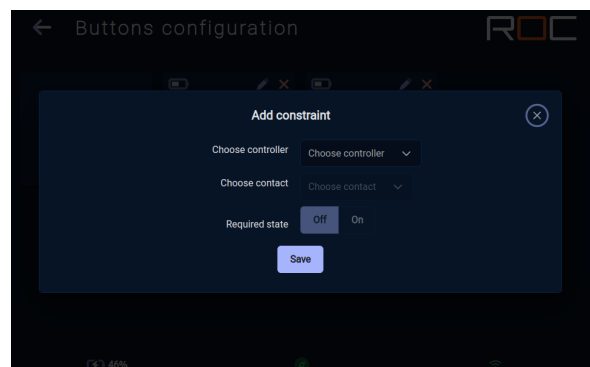

Module type

Once a button has been created, you can restrict the calling of these buttons to certain types of ROC module; to do this, click on the "All modules" link at the button level, then select the module(s) authorized to respond to a call from this button.

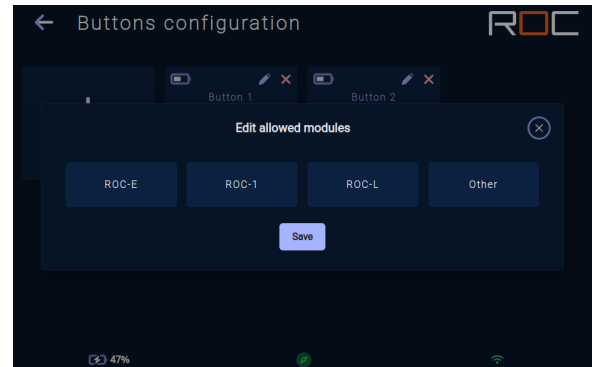

Vehicles

This page lists configured vehicles.

To delete a vehicle, click on the red cross associated with the vehicle.

To add a new vehicle, click on the "Add a vehicle" button and complete the required information.



Waiting points

In some cases, several robots will need to go to the same saved pose at the same time.

To prevent robots from self-blocking, it is possible to set up waiting points so that one of the robots waits on the position until the other robot has left the saved pose.

Prerequisites

To add a new waiting point, you must first create:

- **The saved pose** where there may be a conflict.
- The saved pose corresponds to the **waiting point**.
- **A custom area** must contain the saved pose where there may be a conflict. The robot will send a message to the other robots to indicate that the space is free when it leaves this zone.

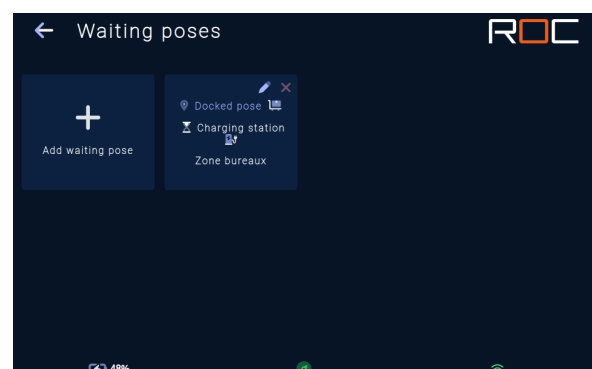

Custom commands

Custom commands can be created to instruct a LoRa controller to activate one of its relays at a particular time, or to pause robot movement depending on the state of a LoRa controller contact.

To add a custom order, you must indicate:

- a **title**
- the **trigger zone** (create a customizable zone on the map as a first step)
- the **list of saved poses** for which the order is to be sent (select nothing to apply to all destinations, activate "All except" to select only those positions where the behavior should not be triggered)
- the **triggering moment** (on entering the zone, on leaving the zone, on a movement error, as long as the robot is in the zone)
- the **LoRa controller relay** to activate or the contact to wait for

Examples of use : open an automatic door, switch off a zone alarm system, wait for a door to open before continuing...

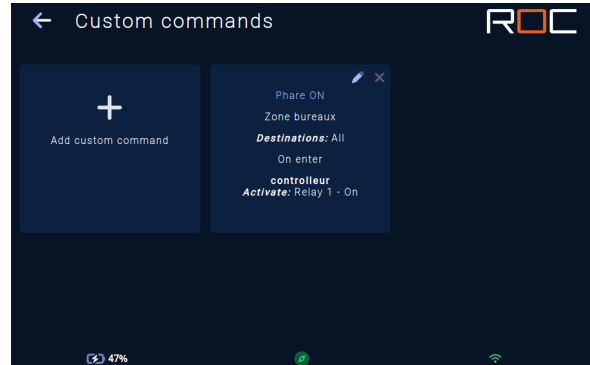

LoRa controllers

This section lets you add, modify and delete LoRa controllers for use in other configurations.

When a controller contact is active, the dot will be green.

When modifying a LoRa controller, it is possible to remotely retrieve the configuration of the controller's contacts. Once this configuration has been retrieved, you can modify the configuration of a contact remotely.

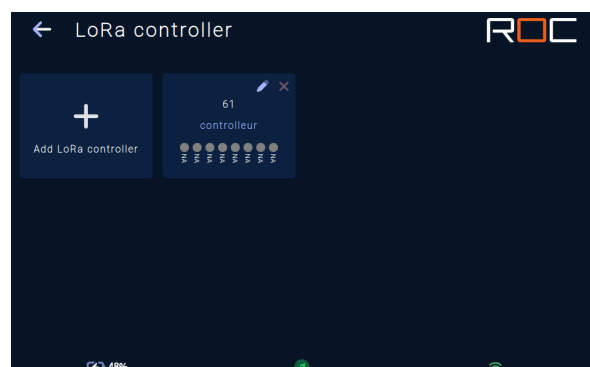

Predefined messages

This section allows you to add, modify and delete predefined messages for use when the robot moves.

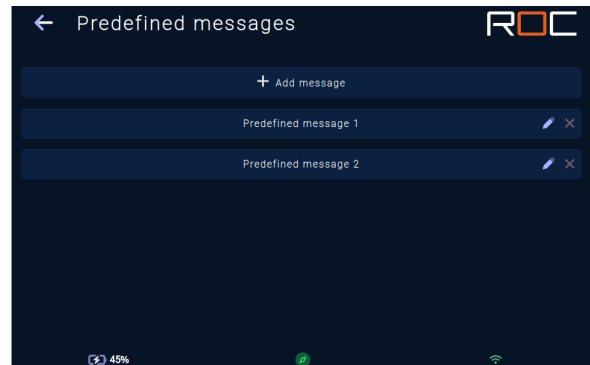

Noeme application

This menu gives you direct access to the vehicle's application.

Please refer to the Noeme application documentation for further details.

Map

This section allows you to:

- add, move and delete saved poses.
- add or remove docked poses.
- add or remove shelf poses.
- modify names, icons and colors of saved poses, charging stations and docked poses.
- configure control of a LoRa controller relay when the robot is in position.
- restrict access to positions to certain module types.
- manage groups.

Add a location

To add a location to the map, click on the “+” button.

Depending on whether or not the ROC-P module is present, you can create three types of positions:

- a saved pose
- a docked pose
- a shelf pose

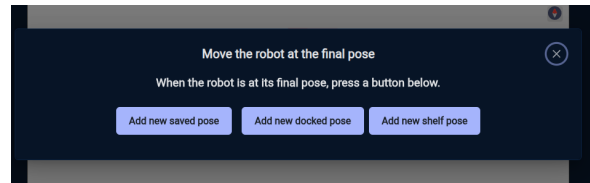

Saved pose

This type of position corresponds to a classic position; the robot will move to this position with an authorized margin of several centimeters.

Docked pose

This type of position corresponds to a precise position; the robot will move to this position with a margin of error of less than one centimeter.

This type of position requires a marker so that the robot can position itself precisely.

In the case of the ROC-P, this type of position is required for picking stations or shelf placement positions.

Shelf pose

In the case of the ROC-P, you must create this type of position at the location where you want a shelf to be picked up.

Modify a position

Depending on the type of position, several options can be modified.

Regardless of the type, you can modify the following options:

- **Color** : icon color.
- **Icon** : icon associated with the position.
- **Name** : name of the position.
- **Activate a relay on the position** : this option allows you to activate a relay on a LoRa controller when the robot is in this position.

To activate a relay, select:

- the controller.
- relay 1 or 2.
- The action on the relay (*On/Off* - to activate the relay when the robot is present, *Pulse* to send a pulse to the relay when the robot arrives).

Docked pose

In the case of the ROC-P, you can indicate the type of station present at this position:

- **None** : no station present, use this configuration for shelf placement.

- **Loading** : for gravity loading stations.
- **Unloading** : for gravity unloading stations.
- **Picking** : for picking stations.

In the case of stations, you can indicate whether or not there is crate detection by completing the contact section.

You must indicate the dimensions of the loads that will be picked up at these stations as well as the height to which the elevator must be raised to pick up the load.

Shelf pose

In the case of the ROC-P and a shelf pose, you must specify the dimensions of the shelf that will be picked up at this position, as well as the height to which the lift must be raised to pick up the load (maximum height; the lift will stop automatically when it detects contact).

Docked or shelf pose

A set of advanced parameters allows you to configure the robot's approach to these positions:

- **Undock distance** : distance the robot must travel to exit this position.
- **Approach distance** : distance at which the robot positions itself before starting the docking phase.
- **Disable safety distance** : distance at which the robot deactivates its safety features to allow it to approach obstacles in the final position.
- **Guided distance** : distance during which the robot can no longer turn before reaching the final position.
- **Max speed** : maximum speed allowed during the docking phase.
- **Contact allowed** : allows or disallows the robot to touch and push against an obstacle.
- **Contact success tolerance** : tolerance in mm for considering the robot's position relative to the final position as a success
- **Motors amps threshold** : maximum motor amperage threshold allowed during the docking phase.
- **Motors amps timer threshold** : maximum duration allowed to exceed the maximum amperage threshold.

Groups

You have the option of creating position groups. A group consists of a main position and several secondary positions.

When a mission is configured to move to a main position in a group, the screen will automatically display the list of secondary positions when the robot arrives at that destination. The user can then ask the robot to move to one of the secondary positions to “complete” the route.

On the home page, the secondary positions of the groups will be hidden and a “+” icon will be added to the main positions of the groups. By clicking on this “+”, you will then be able to access the list of secondary positions for the group.

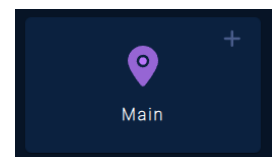

Lift

This section allows you to interact with the ROC-P module lift.

- The top button allows you to raise the lift to its maximum height.
- The second button allows you to raise the lift as long as the button is held down.
- The penultimate button allows you to lower the lift as long as the button is held down.
- The bottom button allows you to lower the lift to its lowest position.

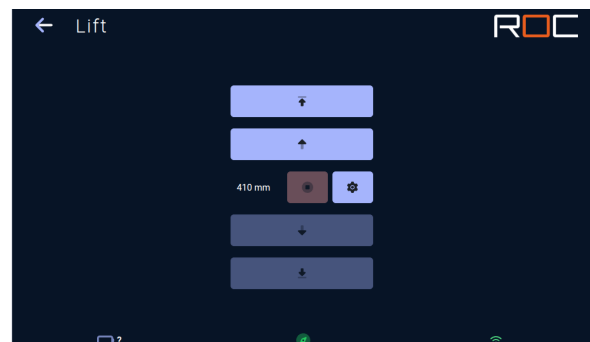

When the lift is moving, the red button allows you to stop its movement.

The button with the cogwheel allows you to configure the height of the top of the lift relative to the ground. To change the configuration, click on the button and enter the actual height of the top of the lift relative to the ground in the input field. This configuration allows the vehicle to check for obstacles before lowering its load.

Security

This section allows you to enable or disable certain features.

- **Enable no SSL (http and ws)** : allows you to enable or disable the use of the application and web services without using an SSL certificate.
- **Enable SSH** : allows you to enable or disable SSH access.
- **Enable modbus IP** : enables or disables the Modbus IP server on the robot.
- **Enable secure LoRa** : allows you to enable or disable the security of messages sent over LoRa by adding encryption and integrity checks. Enabling this feature may result in slower system responsiveness. Please note: if this option is enabled, it must also be enabled on all other devices (manager, robots, buttons, controllers).
- **Connection max try** : number of connection attempts allowed for an IP address before it is banned for a certain period of time.
- **Ban period** : period in minutes during which an IP address is banned in the event of a connection error.

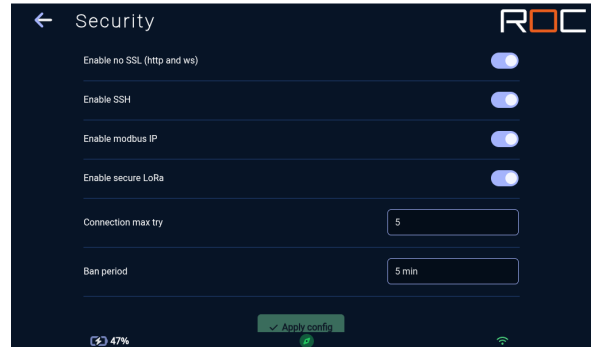

Connectivity

This page lets you activate, deactivate and configure the various WiFi functions for the module and Noeme.

This page also gives vehicles access to port forwarding configuration.

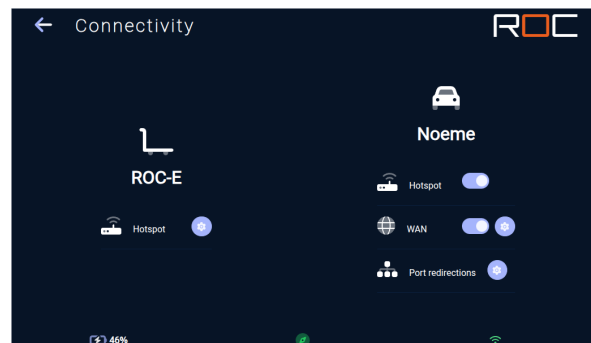

Port redirections

This page lets you enable, disable and configure vehicle port forwarding to other device.

If you connect a device to the vehicle's wired network and it is connected to your WiFi network, port forwarding allows you to access your equipment via your WiFi network and a port forwarding configured on the robot.

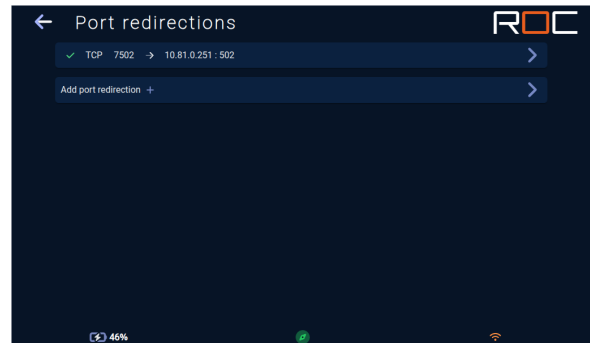

Select map

This page allows you to change the vehicle's **active map** among the maps **created** or **imported** on the vehicle.

It also allows renaming and deleting sites, as well as deleting maps.

In this "tree" view, the **sites** (containing the maps) are visible on the left side of the tree, and the **maps**, their names, and their **previews** are located under the parent site.

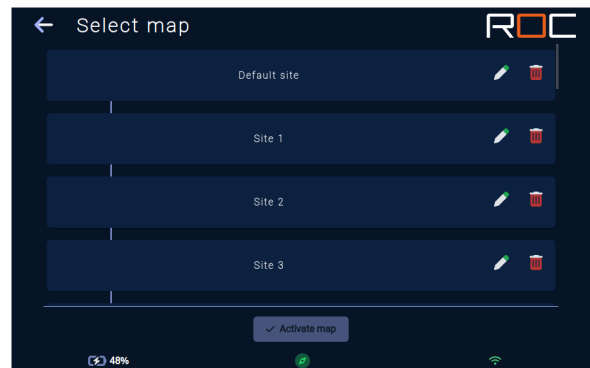

The pencil button allows you to modify the **name** and **description** of a site. The trash button allows you to delete, with **confirmation** required.

It is not possible to delete the active site or the active map.

Once the selection is complete, the button at the bottom of the page allows you to initiate the **map change**.

The vehicle will start by replacing its **active map**, then it will perform a **relocation** to start **autonomous navigation** on its new map.

Import / Export

This page lets you import/export configurations.

Export: click on the "Export" button to download configurations (to save them or to import them on another robot or manager).

Import: click on the "Import" button, then select the file to be imported.

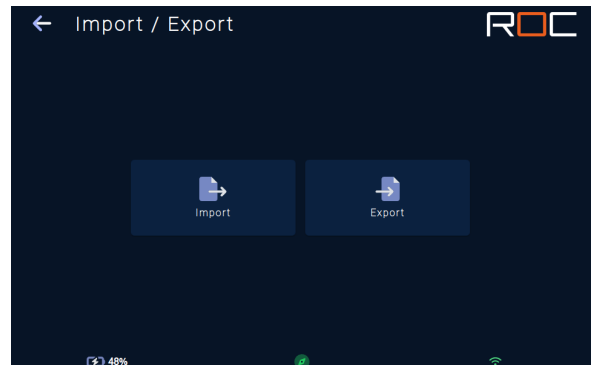

Languages

This page lets you choose the application language.

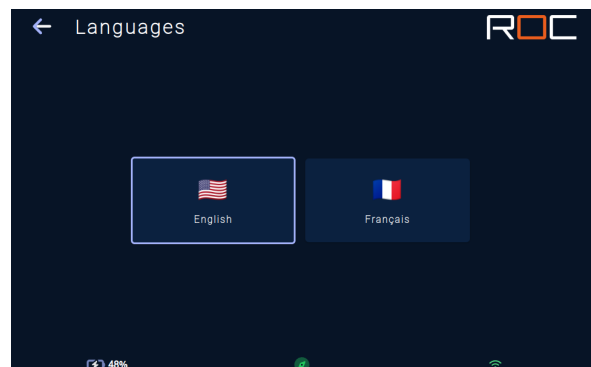

User accounts

This page allows you to add, modify or delete a user account.

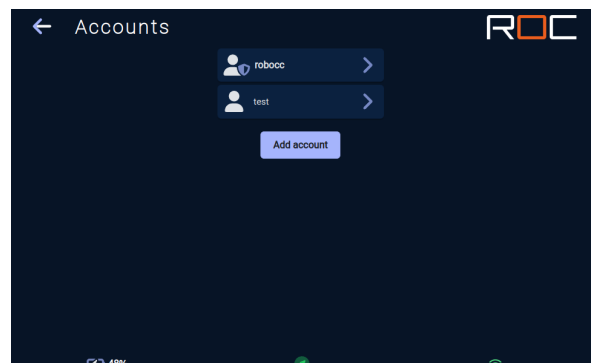

Sound volumes

This page lets you set a **maximum volume** for each **scenario** of **sounds emitted** by the vehicle.

The general volume acts as an upper limit for all other values.

*If set to 30, other volumes cannot exceed 30.

The following scenarios can be configured:

- **Initialization** : Sounds when the vehicle is **started** .
- **Hotspot connection** : Sounds emitted when a device is **connected** to the vehicle's **WiFi hotspot** .
- **IHR** : Sounds emitted when the vehicle is **expecting human intervention** (Intervention Humaine Requite).
- **Obstacle** : Sounds emitted when the vehicle detects an **obstacle** while traveling.
- **Special behaviors** : Sounds emitted when the vehicle is in a particular state.
- **Autopilot** : Sounds emitted during the **steps** of sounds in a sequence of the vehicle's **autopilot** mode.
- **ROC sounds** : Sounds emitted during missions.
- **Settable areas** : Sounds emitted when the vehicle enters, exits or is in a **settable area** in which **sound behaviors** have been configured.
- **Safety disabled** : Sounds emitted when safety disabled on docking.

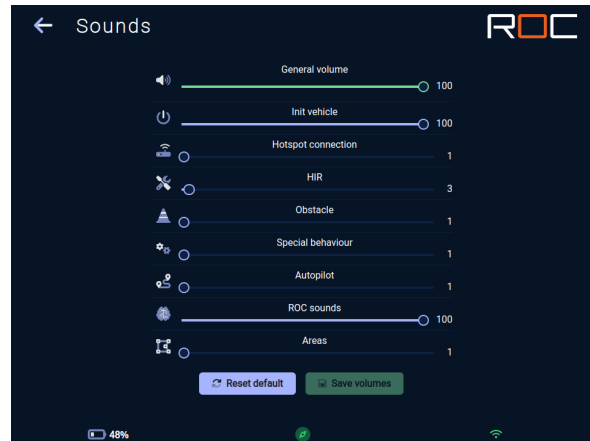

Maintenance mode

Click this button to activate or deactivate maintenance mode.

This button is only visible on a manager, and is used to pause the system.

If maintenance mode is enabled, the button icon will be orange.

Refresh

Click this button to force a complete page refresh.

This action may be useful after an application update.

Restart

Click on this button to completely restart the application and return it to its start-up state.

Statistics

The statistics page gives you access to a set of graphs and heatmaps showing how the solution is working.

The Export button lets you export the application's raw data to generate your own usage statistics.

Home

Provides an overview of solution usage.

A filter system lets you select the date and period of data analyzed.

Calls

Allows you to view a set of graphs on calls made to the solution.

Calls by button

View the number of calls per button.

Destinations

Provides statistics on the most popular destinations, as well as a heatmap.

Delays

Allows you to consult statistics on intervention times on the solution:

- Travel time
- Assistance in the event of a problem
- Release time

Movement error

View statistics on displacement errors and a heatmap to see where problems occur.

HIR

View statistics on HIR (Human Intervention Required) errors and a heatmap to see where problems occur.

Missions

The "missions" page is only available to managers.

It allows you to consult the list of current missions and to create new missions.



Creating a new mission

Create new mission

By clicking on the "Create new mission" button, you can create a new customized mission to send to the robots.

- Step 1: choose between a multidestination mission or an ordered multidestination mission.
- Step 2: choose destinations.
- Step 3: choose the type(s) of module(s) authorized for this mission (if you don't select a module, they will all be authorized).
- Step 4: choose one or more robots authorized for this mission (if you don't select any robot, they will all be authorized, if you select only one robot, the mission will be directly assigned to it).

Start button mission

By clicking on the "Start button mission" button, you can create a new mission to be sent to the robots from the pre-configured buttons. This works in the same way as pressing a LoRa button.

- Step 1: choose the pre-configured button.
- Step 2: select one or more robots authorized for this mission (if you don't select any robot, they'll all be authorized, if you select just one robot, the mission will be directly assigned to it).

Mission lists

The first list shows priority missions.

The second, non-priority missions (by default).

A non-priority mission will be given priority if the first robot is unable to carry out the mission (as soon as another robot is available, it will give priority to this mission).

Mission

Basic information is displayed:

- Active mission stage and destination.
- Mission number or associated button.
- The robot assigned to the mission.

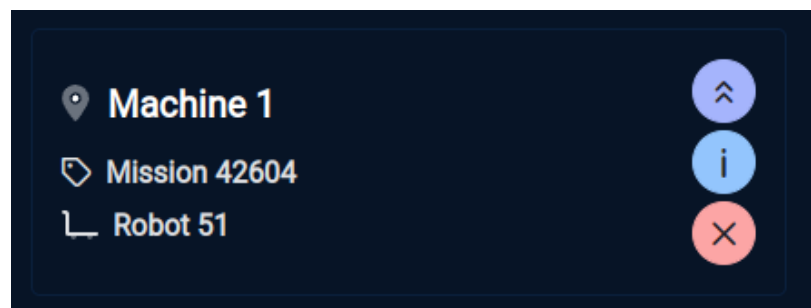

3 interaction buttons are available:

- Skip priority mission.
- View mission details.
- Cancel mission.

Mission details

This popup allows you to view the mission details with all its steps.

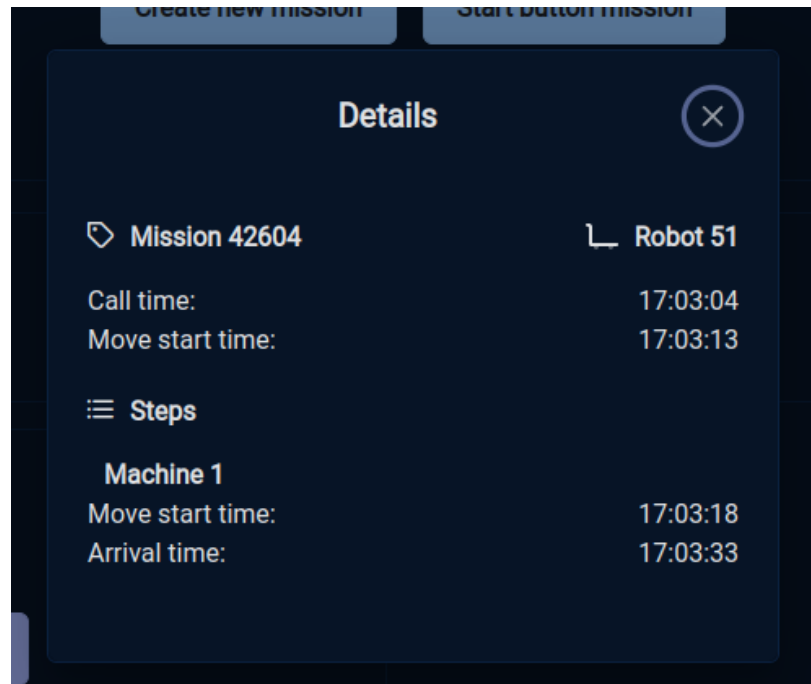

Release a robot

When a robot is waiting to be released, the "Release robot" button appears.

This button lets you release the robot so that it can move on to its next step, or return to charge if its mission has been completed.

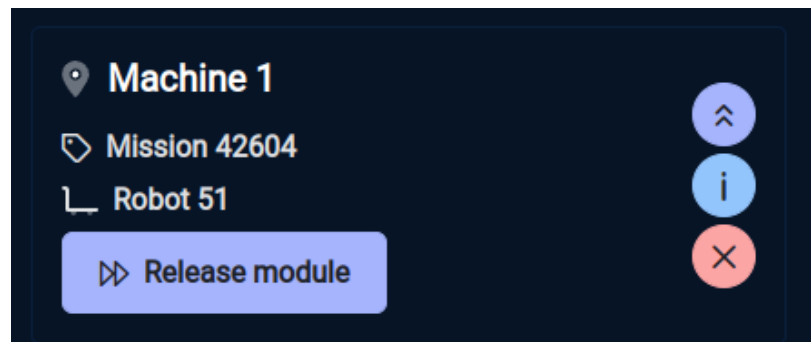

Extend a mission

When a robot is waiting to be released and has completed its mission, the "Extend mission" button is displayed.

This button lets you specify the next steps in the robot's mission.

The robot will be automatically released when it receives these new steps.

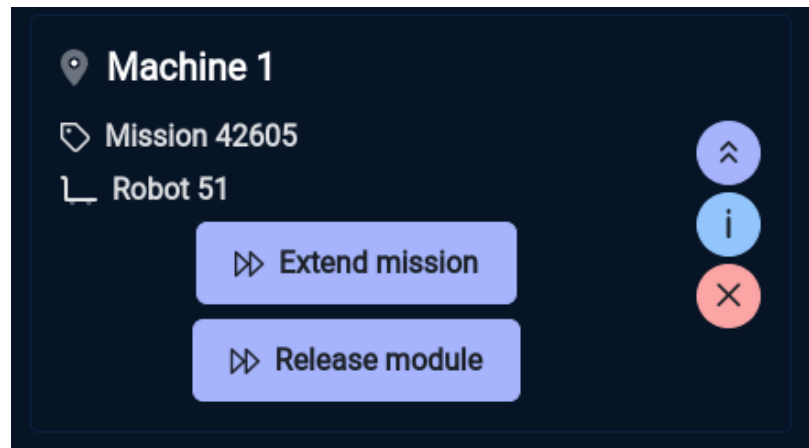

Call buttons user manual

How it works

Start a call

Short press the physical button to launch a call.

The display will show a phone.

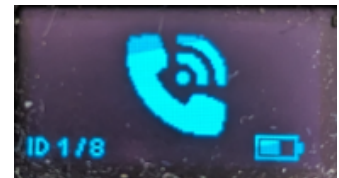

Once the call has been received by the manager, the screen will display a ticket with the position number in the queue.

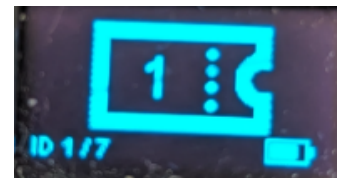

As soon as a robot is assigned to the mission, the screen displays the robot icon with an arrow.

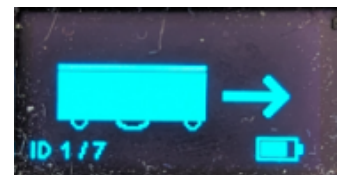

Once the robot has arrived, the screen will display the robot icon with a tick, then switch off.



If the robot fails to come to the requested position, the screen will display the robot icon with a cross. This display will remain active until another robot is assigned to the mission.



If no equipment answers the call after 10 seconds (SP configuration problem or no manager on), the display will show a phone with a cross and then switch off.

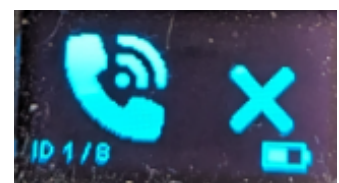

If the manager is in the process of being configured, the display will show a tick and then switch off.



Cancel a call

During a call, press and hold to cancel the call.

The display will show a phone with a cross.

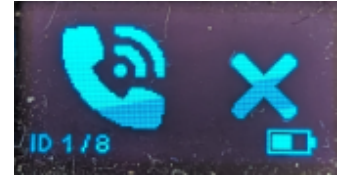

Recharge the button battery

To charge the button battery, connect the button to a device (PC, power bank, AC adapter, etc.) using a **USB-C** <-> **USB-A** cable.

Caution: Do not use a **USB-C** <-> **USB-C** cable.



Configuration

Press and hold the button for 3 seconds to access the menu.

Menu

Quickly press the physical button to change menu, long press to enter menu.

- LoRa SP
- Button
- Secure LoRa
- **Restart** : restart the controller, to be done after a modification.
- **Close** : close the menu.

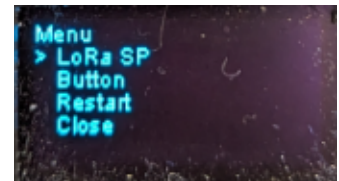

LoRa SP

This page is used to configure the controller's SP.
The SP must be set to the same SP as the manager and robots.

Quickly press the physical button to change a value or validate a button, long press to change fields or buttons.

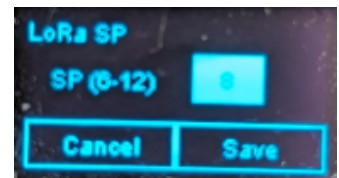

Button

Unique button identifier from 1 to 99.

It must be unique and will be configured on the manager and robots.

Quickly press the physical button to change a value or validate a button, long press to change fields or buttons.

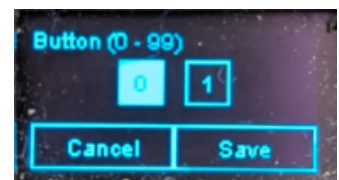

Secure LoRa

Enable or disable security mode on LoRa communications.

Please note: all equipment must have the same configuration.

Press the physical button briefly to switch lines, press and hold to confirm the selected option.

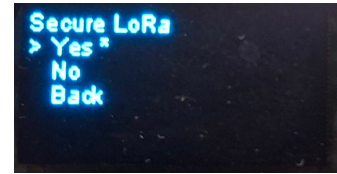

LoRa controllers user manual

Principle

LoRa controllers are equipped with 2 relays and 8 dry contacts. They can be used to control equipment or be controlled by equipment/sensors.

LoRa controllers must be connected to a power supply between 12V and 24V DC.

LoRa controllers should be installed on a DIN rail.

Views



Front view

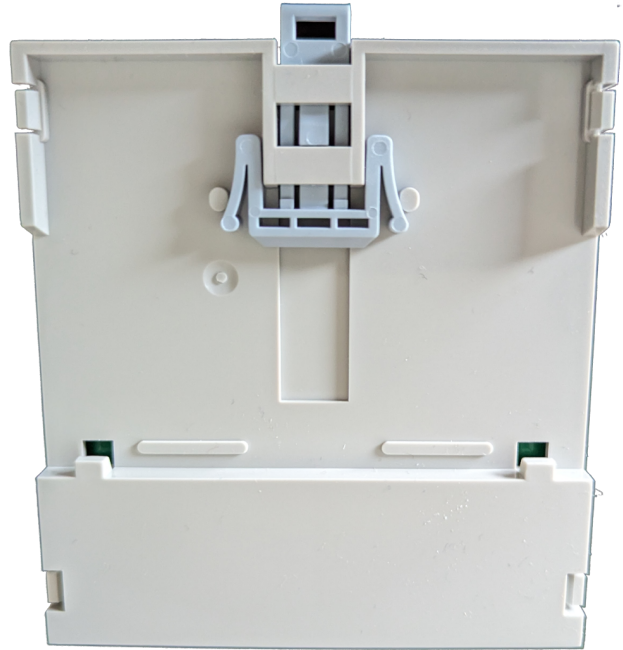

Rear view

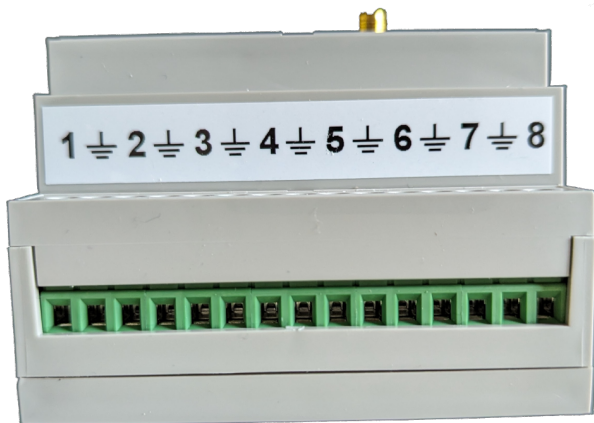

Top view

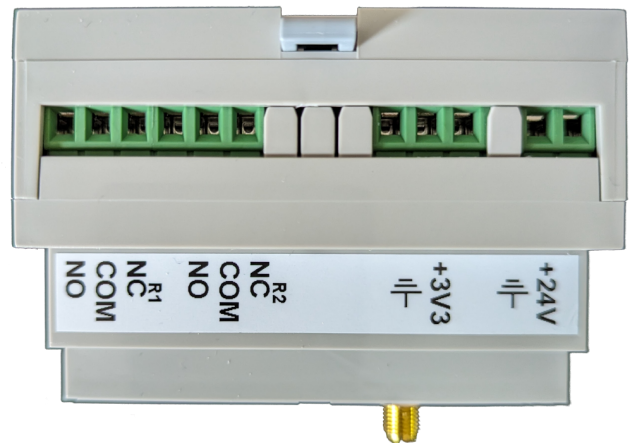

Bottom view

Configuration

Press and hold the button for 2 seconds to access the menu.

Menu

Quickly press the physical button to change menu, long press to enter menu.

Menu

- LoRa
- Controller
- Relays
- Contacts
- Secure LoRa
- Restart : restart the controller, to be done after a modification.
- Close : o close the menu.

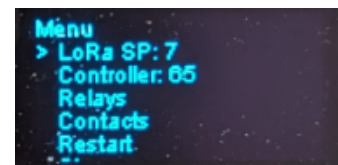

LoRa

This page is used to configure the controller's SP.
The SP must be set to the same SP as the manager and robots.

Quickly press the physical button to change a value or validate a button, long press to change fields or buttons.

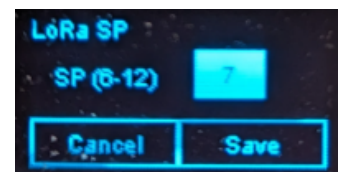

Controller

Unique controller identifier between 1 and 99.
It must be unique and will be configured on the manager and robots.

Quickly press the physical button to change a value or validate a button, long press to change fields or buttons.

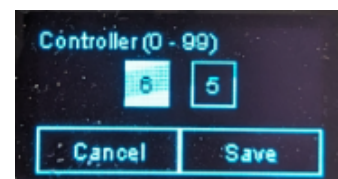

Relays

Allows you to modify the relay activation time on a pulse command in tens of milliseconds and test relays.

Quickly press the physical button to change menu, long press to enter menu.

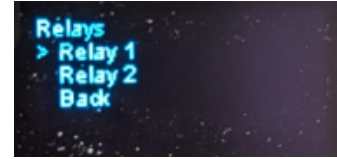

Relay

Once on a relay page :

- **Pulse** : set the pulse duration,
- **Test** : test the relay,
- **Back** : return to the previous page.

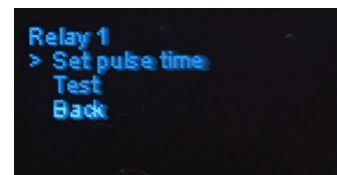

Relay - Set pulse time

Once on the page, press the physical button quickly to change a value or validate a button, and press and hold to change fields or buttons.

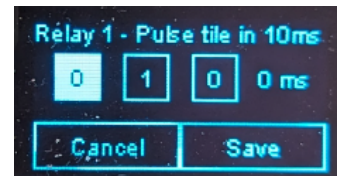

Relay - Test

This page allows you to :

- **Set pulse time** : send a pulse to the relay
- **ON** : activate the relay
- **OFF** : deactivate the relay

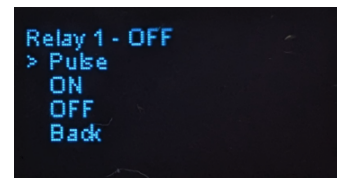

The active state of the relay is shown at the top of the page.

Contacts

Allows you to modify contact configuration.

Quickly press the physical button to change menu, long press to enter menu.

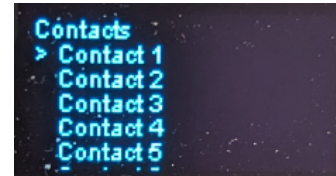

Contact

Once on a contact's page, you can choose its type:

- **None** : no configuration
- **Call**
- **Priority call**
- **Availability**

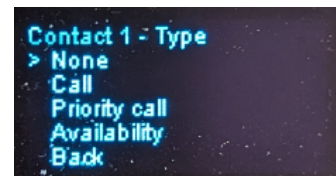
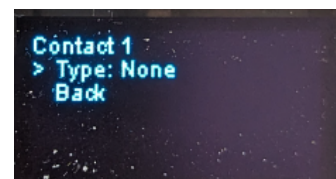

Contact *Call* / *Priority call*

If the contact type is *Call* or *Priority call* , new configurations are available:

- **NO/NC** : indicate whether the contact is normally open or closed.
- **Trigger** : indicate whether the call should be triggered on an impulse or when the contact is "high".

In the case of "high" contact configuration, if the status changes to "low", the call will be cancelled.

The "high" configuration is generally used for presence contacts.

- **on high**
- **on pulse**
- **ID button** : Identifier of the button used to generate the call.

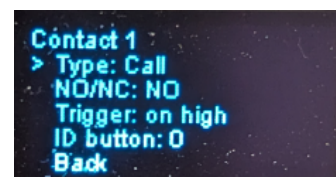

Contact Availability

If the contact type is *Availability* , a new configuration is available:

- **NO/NC** : indicate whether the contact is normally open or closed.

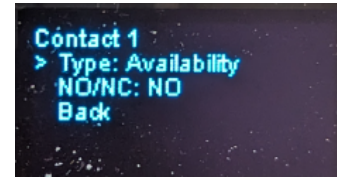

Contact Release robot

If the contact type is *Release robot* , new configurations are available:

- **NO/NC** : indicate whether the contact is normally open or closed.
- **UUID** : Unique identifier of the map element where the robot is to be released (UUID in hexadecimal).

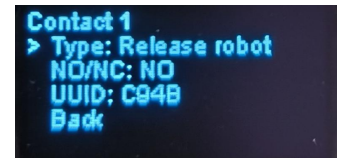

Secure LoRa

Enable or disable security mode on LoRa communications.

Please note: all equipment must have the same configuration.

Press the physical button briefly to switch lines, press and hold to confirm the selected option.

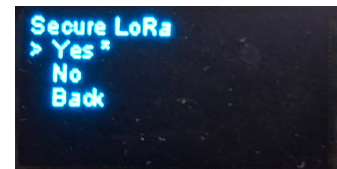

Case studies

Set up a shelf

Description

A **ROC-E** equipped with a **Picker** module (**ROC-EP**) can move a shelf equipped with the hooking system.

To move a shelf, the robot needs:

- a specific position for picking up the shelf,
- a specific position for placing the shelf.

The specific position for placing the shelf must be in close proximity to a marker so that the robot can place the shelf accurately.

When placing the shelf, the robot will first check that the space required for the shelf is free.

Configuration

Position for shelf mounting

- Place the shelf where it needs to be picked up.
- Place the robot under the shelf (the robot's position does not need to be very precise; the robot will automatically reposition itself in the correct place when picking up the shelf, based on its actual position).
- On the robot screen:
 - Go to the **Configuration** section by clicking on the button at the bottom right and enter the access code.
 - Go to the **Map** section by clicking on the dedicated button.
 - Click on the **+** button to add a new item.
 - Click on the **Add new shelf position** button.
 - Then modify the new position created;
 - Customize the name, icon, and color of the position.
 - Enter the dimensions of the shelf (width, depth, height, and weight).
 - Configure the height of the lift; this height will be the maximum height to which the lift can rise, and the lift will stop automatically when it detects contact with the shelf; this height must therefore be slightly higher than the position when contact is made.
 - Click on the **Lift height** button.
 - Click on the arrows to adjust the height of the lift; the shelf should be slightly raised.

- Click on the **Use this position** button.

Position for shelf unload

- Place a marker near the placement location. This marker must be visible to the robot as it approaches and once it is in position.
- Place the robot at the desired location for placing the shelf. This position must be precise.
- On the robot screen:
 - Go to the **Configuration** section by clicking on the button at the bottom right and enter the access code.
 - Go to the **Map** section by clicking on the dedicated button.
 - Click on the **+** button to add a new element.
 - Click on the **Add new docked position** button.
 - Then modify the new position created; customize the name, icon, and color of the position.

Set up a picking station

Description

A **ROC-E** equipped with a **Picker** module (**ROC-EP**) can automatically pick up and drop off crates at picking stations.

In order to pick up or drop off a crate at a picking station, the robot needs a specific position for the picking station.

When dropping off, the robot will first check that there is no crate already present at the picking station.

Configuration

- Place the picking station at the desired location for picking up or dropping off crates.
- Place the robot precisely under the picking station (the robot will move to this exact position each time).
- On the robot screen:
 - Go to the **Configuration** section by clicking on the button at the bottom right and enter the access code.
 - Go to the **Map** section by clicking on the dedicated button.
 - Click on the **+** button to add a new item.
 - Click on the **Add new docked pose** button.
 - Then modify the newly created pose;
 - Customize the name, icon, and color of the position.
 - Select **Picking** from the **Station Type** options.
 - Enter the dimensions of the crate (width, depth, height of the robot + crate, and weight).
 - Configure the height of the lift.
 - Click on the **Lift Height** button.
 - Click on the arrows to adjust the height of the lift; the box must be raised 1 cm above the station.
 - Click on the **Use this position** button.

Repeat this configuration for all picking stations.

Configure door opening

Description

Using a **LoRa controller**, a robot can control the opening of automatic doors.

To control an automatic door, the robot needs:

- a custom area to activate the door opening in one direction,
- a custom area to activate the door opening in the other direction.

If the automatic door is equipped with a presence detector to open automatically in one direction of passage, the custom area will not be necessary.

A **LoRa controller** can control up to two nearby doors.

Installing the LoRa controller

Connection

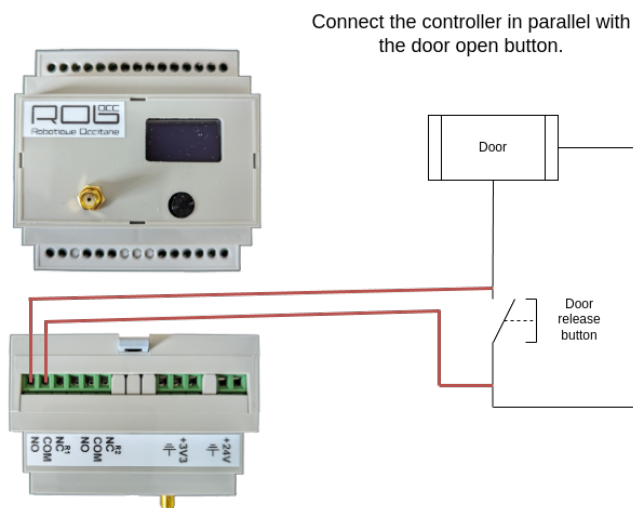

Configuration

Refer to the documentation for the **LoRa controller** to configure the pulse duration to be used to open the door. Generally, a 200 ms pulse is enough to open automatic doors.

Test

Consult the documentation for the [LoRa controller](#) to test the configuration and verify that the door opens.

Preparation of areas

As indicated in the introduction, it is necessary to define areas to control the opening of automatic doors.

The principle is as follows: if the robot needs to pass through the automatic door, it will trigger the opening command as soon as it enters the area.

It is therefore necessary to create an area “in front of” and “behind” the door to trigger the command.

The size of the area depends on the speed at which the door opens. If a door is slow, a large area will be set up to trigger the opening as soon as possible and facilitate the robot's navigation.

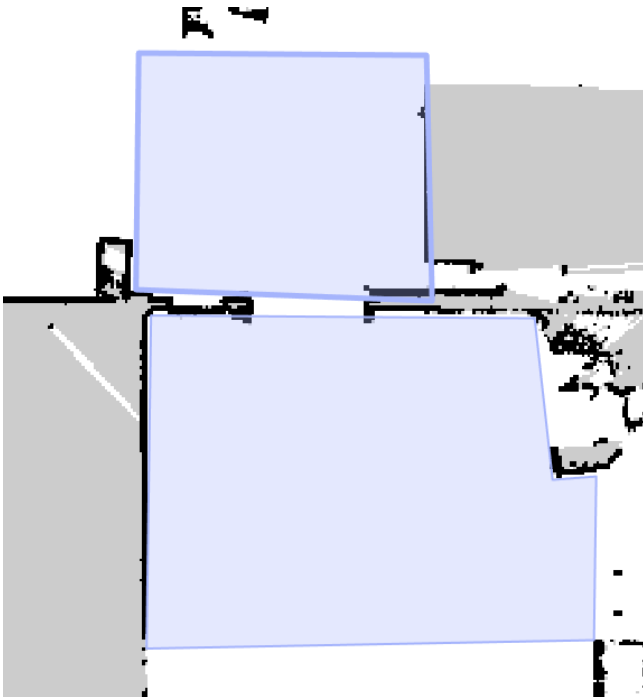

To add an area to the map:

- On the robot screen:
 - Go to the [Configuration](#) section by clicking on the button at the bottom right and enter the access code.
 - Click on the [Advanced Settings](#) menu.
 - Log in if necessary.
 - Click on the [Map](#) menu.
 - Click on the configuration icon in the menu on the left.
 - Click on the blue icon for custom areas.

- Draw the desired area on the map.
- Change the name in the left panel to make it easier to find the area later.

Configuration

Add the LoRa controller

The first step in the configuration process is to add the LoRa controller in the system.

- On the robot screen:
 - Go to the **Configuration** section by clicking on the button at the bottom right and enter the access code.
 - Click on the **LoRa Controllers** menu.
 - Click on the **Add a LoRa controller** button.
 - Enter the controller ID (displayed on the controller screen).
 - Enter a name (e.g., Door Opening).
 - Click on the **Add** button.

Configuring custom commands

The second step of the configuration process consists of configuring the robot to send an open command when it needs to go through the door.

- On the robot screen:
 - Go to the **Configuration** section by clicking on the button at the bottom right and enter the access code.
 - Click on the **Custom Commands** menu.
 - Click on the **Add Custom Command** button.
 - Enter a name (e.g., Open door to enter).
 - Select the command trigger zone (zone “in front of” or “behind” the door).
 - Select all targeted positions where the robot needs to open the door. You can activate the **All except** switch at the top so that you only have to select the positions that are not concerned.
 - Select **On enter** and **In the area** .
 - Select the controller you created earlier.
 - For the command, select **Relay 1 > Pulse** (or relay 2 if the door has been connected to relay 2).
 - Click on **Add** .

Repeat this configuration to open the door in the other direction of navigation.

Set up a waiting point

Description

In the case of a fleet of robots, several robots may become stuck in certain situations, such as when there is a narrow corridor with no alternative route.

In these cases, it may be useful to set up waiting points so that one robot can clear the way for the others.

It may also be useful to set up a waiting point in cases where an alternative route exists but using it would result in too much time being lost.

To set up a waiting point, the robot needs:

- a destination (the robot will only go to the waiting point if it is heading towards the destination, which allows for waiting points on either side of the corridor depending on the robot's movement),
- a waiting position,
- the area to be cleared.

If the robot fails to move into the area to be cleared (for example, if another robot is present in the opposite direction), the robot will automatically go to the waiting position.

The robot will automatically restart after `x` minutes (`x` can be configured in the delay settings) or if another robot indicates that it has just left the area.

Preparation of areas

Area to be cleared

- On the robot screen:
 - Go to the **Configuration** section by clicking on the button at the bottom right and enter the access code.
 - Click on the **Advanced Settings** menu.
 - Log in if necessary.
 - Click on the **Map** menu.
 - Click on the configuration icon in the menu on the left.
 - Click on the blue icon for custom areas.
 - Draw the desired area on the map.
 - Change the name in the left panel to make it easier to find the area later.

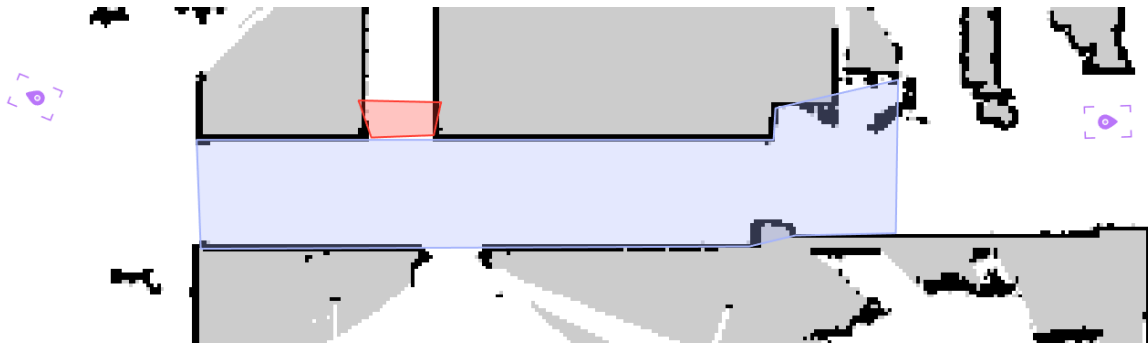

Waiting position

- On the robot screen:
 - Go to the **Configuration** section by clicking on the button at the bottom right and enter the access code.
 - Click on the **Map** menu.
 - Click on the green **+** button.
 - Click on the **Add new saved pose** button.
 - Select the newly created pose.
 - Click on the pencil button to edit it.
 - Change the name to make it easier to find the position later.

Configuration

Once the area and the waiting position have been created;

- On the robot screen;
 - Go to the **Configuration** section by clicking on the button at the bottom right and enter the access code.
 - Go to the **Waiting Poses** section by clicking on the dedicated button.
 - Click on the **+ Add a waiting pose** button.
 - Select the destination; this waiting pose will only be used if the robot is heading towards this destination.
 - Select the previously created waiting pose.
 - Select the previously created area.

Set up predefined messages

Description

In some cases, it may be useful for an operator to leave a message for the operator at the station where the robot is sent.

Our solution allows you to configure predefined messages that the operator can select to be displayed when the robot arrives at its destination.

For example, the robot can be used to send products to the control department, and it may be useful for the operator to specify whether it is a first in a series or a random sample.

Configuration

- On the robot screen:
 - Go to the **Configuration** section by clicking on the button at the bottom right and enter the access code.
 - Go to the **Predefined messages** section by clicking on the dedicated button.
 - Add one or more messages by clicking on the **+ Add message** button.
 - Enter your message
- Add the message

Once a message has been added, it can be modified or deleted using the dedicated buttons.

Usage

Once one or more predefined messages have been configured, the user will have access to new buttons to indicate a message;

- Main page; a button at the top right allows the user to select the message for the next mission. By clicking on the button, the user can select the message from the list of existing messages.

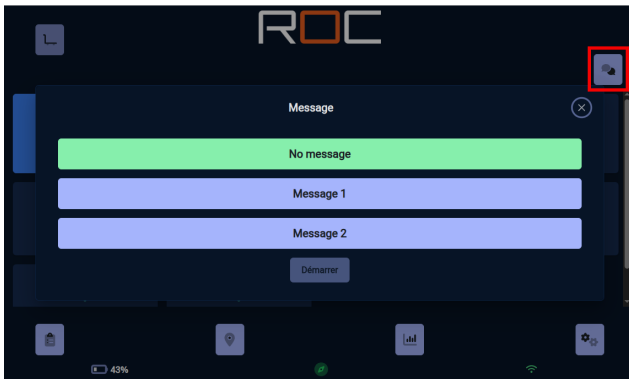

- Multiple destinations and ordered multiple destinations; once a destination has been selected, a button allows you to select the message to be displayed when the robot reaches the selected destination.

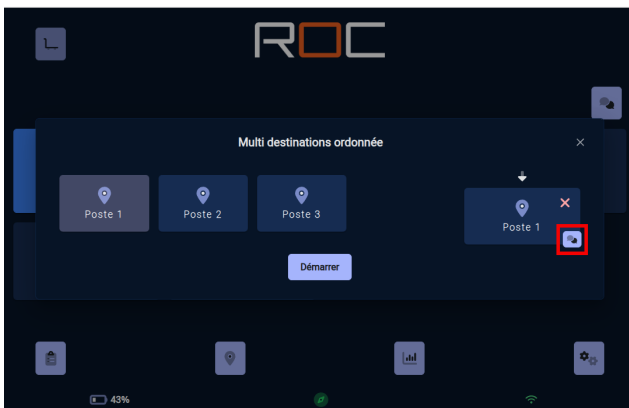

The robot will automatically display the predefined message(s) at the appropriate time.

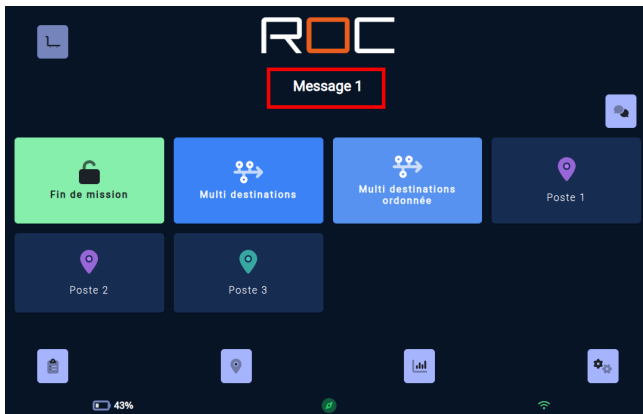

Synchronize robots and manager

Description

The robots in a fleet and the manager need to be synchronized to use the same map and the same configuration.

It is therefore necessary to update the equipment once a modification has been made to one device (robot or manager).

For simple modifications, it may be quicker to reconfigure each device (for example, to add a button).

The potential risk is that one device will not have the same configuration as the others (for example, a robot may not recognize the configuration of a button and therefore be unable to perform that task).

For more complex modifications, the simplest and most reliable method is to export the configuration of the device where the modification was made, then import it onto the other devices.

Export

Connect with a phone, tablet, or PC to the device's WiFi hotspot (robot or manager).

You will find the WiFi network password on the memo sheet provided with the device (if you have not changed the password).

Once connected to the Wi-Fi, open a web browser and go to: <http://10.46.0.254> Log in with the username and password provided on the memo sheet of the robot (if you have not changed the username or password).

- Go to the **Configuration** section by clicking on the button at the bottom right.
- Go to the **Import/Export** section by clicking on the dedicated button.
- Click on the **Export** button to download the configuration file (your browser may ask you to confirm).

Import

Once the export has been downloaded, connect with the same device (phone, tablet, or PC) to the Wi-Fi hotspot of the other devices (robot and manager). You will find the Wi-Fi network password provided on the memo sheet of the device (if you have not changed the password).

Once connected to the Wi-Fi, open a web browser and go to the address: <http://10.46.0.254> Log in with the username and password indicated on the memo sheet provided with the robot (if you have not changed the username or password).

- Go to the **Configuration** section by clicking on the button at the bottom right.
- Go to the **Import/Export** section by clicking on the dedicated button.
- Click on the **Import** button and select the file you downloaded earlier.
- In the case of robots, you may be asked to select the default charging station.

Add constraints on button missions

Description

In some cases, it may be useful to make the execution of a task dependent on a physical element (presence of a load in a given location, machine in a certain state, etc.).

Our solution allows constraints to be added to the stages of a mission so that the robot is only allowed to continue its mission in certain cases.

Prerequisites

One or more LoRa controllers must be configured on the solution.

The constraints will be linked to the status of one of the LoRa controller's dry contacts.

Configuration

When configuring a button, a button with a padlock icon appears on the mission steps. To add a constraint to the step, click on this button. You will then be able to create one or more new constraints.

To configure a constraint, you must:

- Select the LoRa controller
- Select the contact linked to this constraint
- Indicate whether this contact must be in the **On** or **Off** state for the robot to execute the step.

My robot isn't moving anymore. Why?





In certain situations, the robot may stop moving or stop during a movement. To determine the cause, look at the colors of the LEDs on the robot:

- The LEDs are red; the robot is in HIR (Human Intervention Required) mode, and the robot's screen displays the procedure for unblocking the robot.
- The LED corners are orange during movement: the robot's sensors have detected an obstacle blocking its movement.
- All LEDs are off; the robot has no battery power left; move the robot to its charging station to recharge it.

If the LEDs are not in one of the above states,

- Check that a movement command has been sent to the robot.
- The robot cannot find a path to move to its destination;
 - Clear the space around the robot or move it to a free area.
 - Check that the destination saved on the map is not too close to a wall or obstacle.

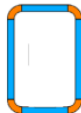
RUBANS LEDS

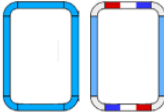
Animation LED	Situation	Résolution
Rouge 	ERREUR : intervention humaine requis	<ul style="list-style-type: none"> • Appuyer sur bouton au-dessous de la zone blanche ou • Contacter le support
Orange 	ALERTE : intervention humaine requise	<ul style="list-style-type: none"> • Appuyer sur bouton au-dessous de la zone blanche ou • Eloigner le robot des obstacles ou • Placer le robot sur sa station de charge
Coins oranges 	Obstacle sur la trajectoire	<ul style="list-style-type: none"> • Attendre que le robot modifie sa trajectoire ou • Retirer l'obstacle
Vert 	Batterie en charge	/
Bleu ou drapeau français 	En navigation	/

My robot is jerking in some places, what should I do?

Description

In certain situations, it may appear as though the robot is avoiding “ghosts” obstacles; the LED corners light up orange and the robot goes around an apparently empty area.

This behavior is usually due to a false positive detection by the 3D cameras and/or ultrasonic sensors.

Configuration

To get around this problem, you need to create a custom area on the map where the robot shows this behavior.

Once the area has been created, you can:

- Reduce the sensitivity of the cameras, thereby reducing false positives.
- Disable the ultrasonic sensors. Warning! The ultrasonic sensors are the only sensors on the robot that can detect glass. These sensors must not be disabled near glass doors.

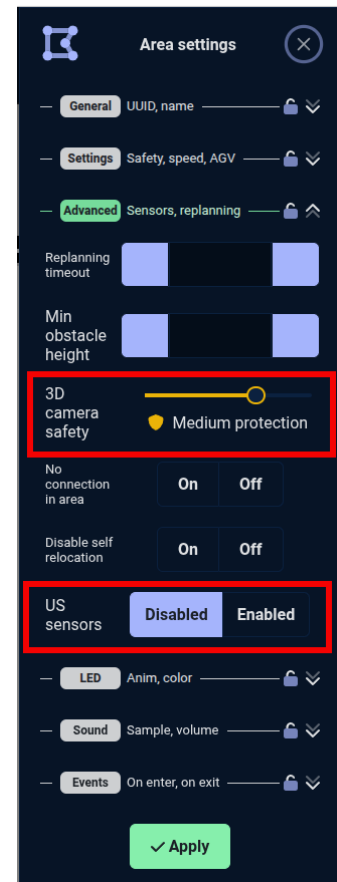

My robot is lost, what should I do?

Description

In certain situations, the robot may become lost (it thinks it is in one location on its map but is physically in another location) or think that it is lost.

The robot can generally become lost in a highly changeable environment where it no longer has any reliable reference points on its map.

It may think it is lost if someone moves it into a forbidden area.

Relocate

In front of the robot, hold down the freewheel button; the screen will display the site map with the robot's position.

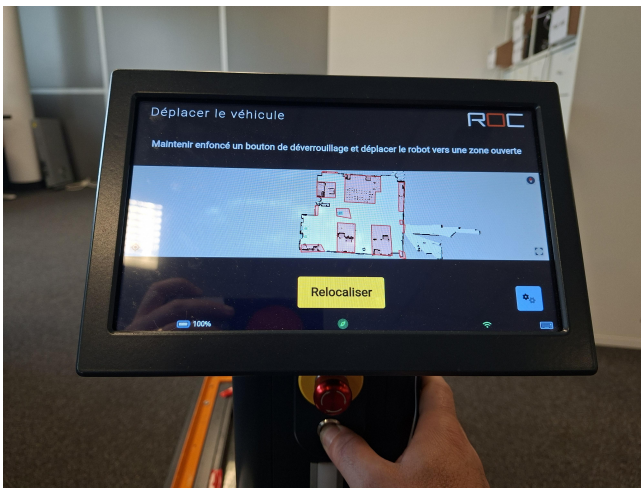

If the robot's position on the map matches its actual position, the robot is not lost. Move it to an open area outside of a forbidden area.

If the robot's position on the map does not correspond to its actual position, the robot is lost and must be relocated.

To relocate the robot, move it in front of a marker (e.g., a charging station). Once the robot has stopped in front of the marker, it will automatically relocate itself and resume its mission.

Configuration

If the robot tends to repeatedly get lost in a particular area, it is possible to create a custom area in which the robot will be prohibited from dynamically relocating itself; the robot will evaluate its position based on its movements without attempting to relocate itself in relation to its map.

- Create a custom area
- Set the `Disable self relocation` option to `ON`



My robot is having trouble entering an area. What should I do?

Description

In some cases, the robot may encounter difficulties when making a sharp turn or entering a room, for example.

In this case, it is possible to “force” the path that the robot will take to make it easier for it to pass.

Configuration

You can “force” the path that the robot will take to make it easier for it to pass by adding forbidden areas.

Turns

To “force” the robot to take a turn more smoothly, adding a forbidden area as shown below may be useful:

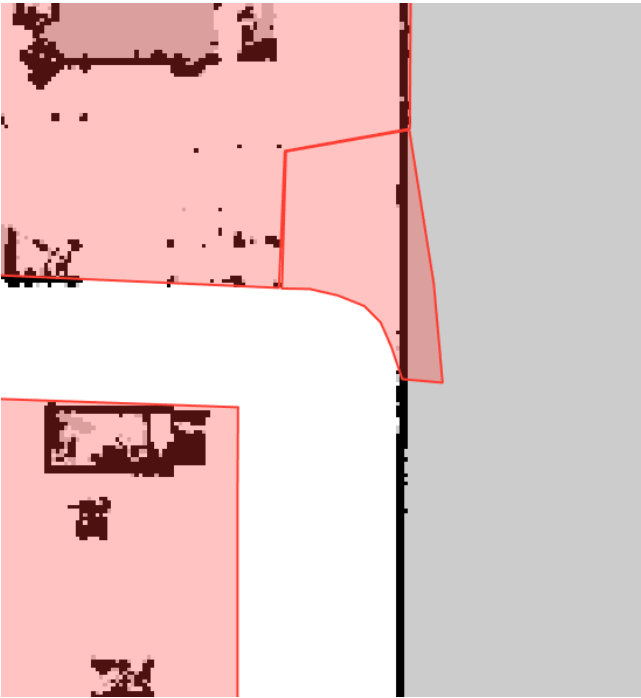

Doors

To “force” the robot to pass through a door more easily, adding two forbidden areas as shown below may be useful:

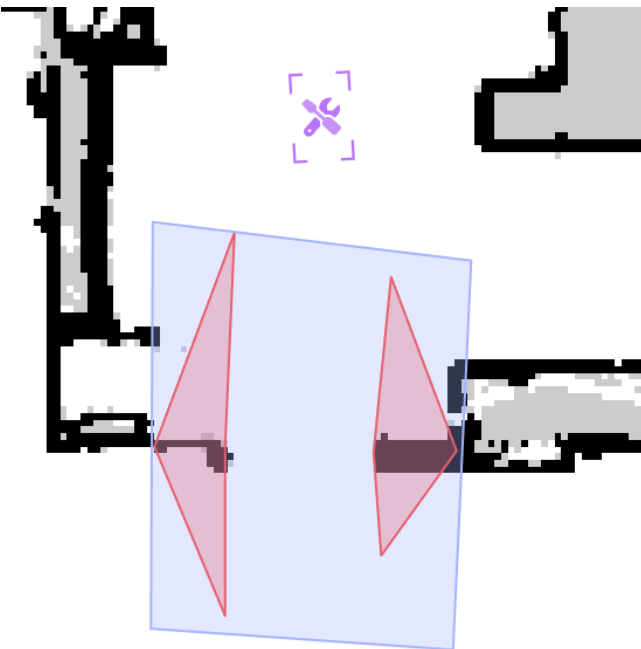

One-way routes

Description

In some locations, traffic rules are in place (such as one-way routes) and must also apply to AIVs.

Our solution allows you to configure these routes on the robot's map and thus apply traffic rules to the robot.

Please note: routes cannot be configured on only part of the map; if a route is required on part of the map, the entire map must consist of routes.

Configuration

Refer to the Noeme documentation, section [Traffic routes](#) .

Add an item with an identical marker already present on the map

Description

Markers are used for several purposes:

- Precise location for robot positioning (charging station, picking station, etc.).
- Automatic relocation of the robot when the freewheel button is pressed.

It is possible to use multiple markers with the same code on the same site.

The problem is that when adding the second marker, if you move the robot using the freewheel button, the robot will relocate itself to the new marker, thinking it is in front of the marker already present on the map.

Tip

The easiest way to add a marker with the same code as another marker already on the site is to:

- Hide the new marker using a sheet of paper or something similar.
- Move the robot to the desired location.
- Remove the sheet of paper or similar to make the marker visible.
- Add this new marker to the map.

